

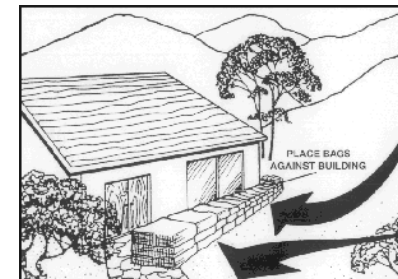

COUNTY OF LOS ANGELES  
DEPARTMENT OF PUBLIC WORKS

# HOMEOWNER'S GUIDE FOR FLOOD, DEBRIS, AND EROSION CONTROL

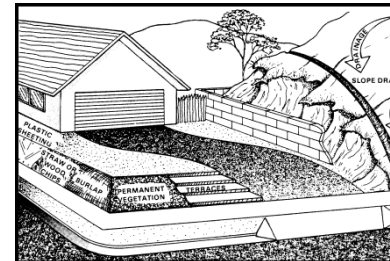

## MISSION STATEMENT

---

Our mission is to assist you and provide information on the installation of inexpensive devices, which will cost less to install and repair than flood damage to your property.

## ASSISTANCE FOR DISABLED PERSONS

---

Questions or concerns regarding information contained in this Guide, or access to any Public Works programs or facilities, should be directed to the Department A.D.A. Coordinator at:



(626) 458-4081 during work hours

You may also obtain assistance by calling the toll free CALIFORNIA RELAY SERVICE numbers at:

Voice: 1-800-735-2922  
TDD: 1-800-735-2929

Or, you may call the Public Works TDD Number at:

(626) 282-7829 during work hours

## ASSISTANCE FOR SPANISH-SPEAKING PERSONS (CONSEJOS EN ESPAÑOL)

---

Si necesita consejos en español con relación al control de inundaciones, escombros y erosión, favor de llamar al Condado de Los Angeles, Departamento de Obras Publicas al

(626) 458-4321

## ATTENTION

---

**This Guide may not be applicable to drainage problems in areas outside of County of Los Angeles. If outside the County, you are advised to contact your local governmental office for additional assistance.**

For additional information on flood protection, please visit one of the following County of Los Angeles Public Libraries:

Malibu Library  
23519 West Civic Center Way  
Malibu, CA 90265

Rosemead Library  
8800 Valley Boulevard  
Rosemead, CA 91770

Castaic Library  
27971 Sloan Canyon Road  
Castaic, CA 91384

For mudflow engineering advice call us at:

(626) 458-6342

For copies of this booklet please write us at:

County of Los Angeles Department of Public Works  
WATERSHED MANAGEMENT DIVISION  
P.O. BOX 1460  
ALHAMBRA, CA 91802-1460

or visit us at:

Watershed Management Division  
900 South Fremont Avenue  
Alhambra, CA 91803-1331

or call us at:

(626) 458-4304

### Lay persons's definitions of flood-related terms (continued)

**Rainy Season** – The period of the year from October 15 to April 15 when County of Los Angeles usually receives its largest amount of rain.

**Riprap** – A layer of large stones or boulders placed together without order, usually used for erosion protection along streams or shore lines.

**Sandbags** – A burlap or plastic bag that can be filled with sand or native soil, which can be stacked or placed to redirect storm and debris flows away from homes or property improvements.

**Slope Drain** – Typically a gunite or concrete V-ditch located horizontally and vertically along residential hillside areas. This device assists in draining the slope to protect against hillside erosion. Typical width is 3 to 5 feet and typical depth is 12". (Same as a Bench Drain)

**Sump** – A low-lying area with no drainage outlet.

**Sump Pump** – A pump designed to pump water out of a sump or basement.

## VI. ACKNOWLEDGMENTS

The County of Los Angeles gratefully acknowledges the technical assistance of the following publications in the preparation of this bulletin:

"*Landscape to Prevent Fire*," published by the University of California Extension Service

"*When Water is Your Enemy*," published by the Contra Costa County Disaster Office



## TABLE OF CONTENTS

	Page
<b>INTRODUCTION</b>	1
<b>I. THE PROBLEMS</b>	2
A. Flood Waters	2
B. Debris Flows	2
C. Erosion	3
<b>II. EMERGENCY HOME PROTECTION</b>	4
A. General Rules	4
B. Flood Insurance	5
C. Debris Control Aids	8
D. Sandbags	9
E. Control of Water Intrusion	14
F. Deflection Devices and Building Protection	17
G. Engineered Concrete Block Walls	19
<b>III. OTHER PROPERTY PROTECTION MEASURES</b>	22
A. General Property Guidelines	22
B. Property Drainage Hints to Homeowners	24
C. Slope (Bench) Drains	26
D. Natural Watercourse Erosion	27
E. Planting Guidelines	29
F. Plant Selection	33
G. Additional Resources for Planting	34
<b>IV. SUMMARY</b>	36
<b>V. GLOSSARY OF TERMS</b>	37
<b>VI. ACKNOWLEDGMENTS</b>	38

LIST OF FIGURES

	Page
Fig.1 Unprotected Homes	6
Fig.2 Homes Protected from Major Damage	7
Fig.3 Typical Materials	8
Fig.4 Sandbag Placement	9
Fig.5 Sandbag Stacking Against Buildings	11
Fig.6 Pyramid Sandbag Stacking	11
Fig.7 Directing Debris Away from Buildings	12
Fig.8 Controlling Debris or Storm Flows in Streets	12
Fig.9 Directing Flows between Buildings	13
Fig.10 Building Protection	13
Fig.11 Sliding Glass Door Sealing	15
Fig.12 Door Seal	16
Fig.13 Submersible Sump Pump	16
Fig.14 Typical Window and Door Protection	18
Fig.15 Use of Window and Door Protection	18
Fig.16 Typical Timber Installation	20
Fig.17 Timber Deflector	20
Fig.18 Telephone Pole or Railroad Tie Barrier	21
Fig.19 Removable Driveway Barrier	21
Fig.20 Erosion Control	23
Fig.21 Property Drainage	24
Fig.22 Slope (Bench) Drain	26
Fig.23 Uncontrolled Chaparral Growth	32
Fig.24 Homes Protected from Fire by Clearing	32

Lay person’s definitions of flood-related terms

**Bench Drain** – Typically a gunite or concrete V-ditch located horizontally and vertically along residential hillside areas. This device assists in draining the slope to protect against hillside erosion. Typical width is 3 to 5 feet and typical depth is 12". (Same as a Slope Drain)

**Debris** – Any combination of soil, rock, mud, trees, or vegetation usually transported by debris flow.

**Debris Flows** – Consist of any soil, rocks, boulders, trees, or brush being moved by stormwaters and containing sufficient strength to destroy or move objects such as cars and buildings in their path.

**Drainage Patterns** – The drainage paths stormwater runoff usually or historically takes through a given area.

**Engineered Concrete Block Walls** – Walls engineered to withstand loads caused by water and debris. These walls are considered to be permanent, and do not require yearly replacement.

**Flood** – (1) A general and temporary condition of partial or complete inundation of normally dry-land areas from the overflow of inland or tidal waters; or (2) the unusual and rapid accumulation or runoff of surface waters from any source.

**Flood Insurance** – Insurance to cover damages to your home, or belongings in your home, caused by flooding, that can be purchased through your local insurance agent.

**Ground Cover** – Typically a low-lying plant that will spread outward, eventually covering all surrounding bare soil.

**Gullying** – Formation of ditches or hollows worn by running water.

**Natural Watercourse** – An unimproved natural stream of any size. Includes rivers, creeks, branches, canyons, arroyos, gullies, washes, etc.

**Ornamentals** – Plants or shrubs grown for their decorative effect.

**Overgrowth** – Foliage that has grown and spread out so as to obstruct or block any natural watercourse, improved drainage device, or structure.

**REMEMBER:**

- DO NOT** underestimate the power of debris flows and flood waters.
- DO NOT** wait until the storm season to start your planning and installation of flood, debris, and erosion control facilities. Start as soon as possible. Once debris flows and flood waters begin, it is usually too late to install protection.
- PROTECTION** is not always pleasing to the eye and appearance should not dictate location or type of installation.
- BE** prepared to personally observe and maintain your installations during storm periods, for in many cases a minor correction will prevent major failure. However, do not take any unnecessary risks.
- SHOULD** your flood, debris, and erosion control problems appear to warrant facilities in excess of the measures described in this pamphlet, it is recommended that you consult a competent expert for additional advice.

The Los Angeles Basin is periodically subject to devastating floods resulting in substantial property damage. Such damage is intensified by debris flows resulting from the destruction of the watershed by major brush fires.

During floods, the prime mission of your Department of Public Works is the control of flood waters in the major rivers and channels throughout the County.

The Department of Public Works has compiled this booklet to assist you in the installation of inexpensive devices, which will cost less to install and repair than flood damage to your property.

The following discussion stresses solutions to problems of particular significance to the growing number of residents in hillside areas. These temporary solutions can be accomplished by individual homeowners. Although the information is intended to develop solutions to reduce the threat of flood damage, there is no guarantee that they will prevent damage or injury.

When the storm season arrives (October to April), flooding and debris flows occur, making it more difficult to perform emergency work. Therefore, I recommend you initiate your preparation for the rainy season immediately.

Gail Farber  
Director of Public Works

## A. FLOOD WATERS

The most common drainage problem in a community is **flood waters**. This occurrence is the mere passage of stormwaters across areas that would normally not be affected in small storms. Remember that flood waters:

- CONSIST** of large quantities of water, often very turbulent and murky due to fine sediment and other soil.
- OCCUR** in moderate to large storms and can reach depths over the head of an individual.
- INUNDATE** large areas and impact any structures in their path.
- DO NOT** refer to ponding or localized drainage around buildings during small to moderate storms.

## B. DEBRIS FLOWS

Another equally dangerous problem, usually in hillside or mountainous areas is **debris flows**. Remember that debris flows:

- CONSIST** of large quantities of soil, rocks, boulders, trees, or brush being moved by flood waters.
- OCCUR** when flood waters flow over hillside and natural streambed areas and are most serious in areas denuded by recent fire or grading.
- ARE** highly destructive and leave large quantities of sediment and rocks in their paths when the storm subsides.
- CONTAIN** sufficient strength to destroy objects in their path.
- CAN** be controlled or directed to reduce property damage (Fig. 2, page 7).

H. ADDITIONAL RESOURCES FOR PLANTING  
(continued)

**The Arboretum**  
**County of Los Angeles Arboretum and Botanic Garden**  
 301 North Baldwin Avenue  
 Arcadia, CA 91007-2697  
 (626) 821-3222  
[www.arboretum.org](http://www.arboretum.org)

**County of Los Angeles**  
**South Coast Botanic Garden Foundation**  
 26300 Crenshaw Boulevard  
 Palos Verdes Peninsula, CA 90274-2515  
 (310) 544-1948  
[www.southcoastbotanicgarden.org](http://www.southcoastbotanicgarden.org)

**County of Los Angeles Descanso Gardens**  
 1418 Descanso Drive  
 La Cañada Flintridge, CA 91011-3102  
 (818) 949-4200  
[www.descansogardens.org](http://www.descansogardens.org)

**Rancho Santa Ana Botanic Garden**  
 1500 North College Avenue  
 Claremont, CA 91711-3157  
 (909) 625-8767  
[www.rsabg.org](http://www.rsabg.org)

**City of Los Angeles Department of Parks and Recreation**  
**Charles F. Lummis Home (El Alisal) and Garden**  
 200 E. Avenue 43<sup>rd</sup>  
 Los Angeles, CA 90031-1304  
 (323) 222-0546  
<http://www.socalhistory.org>

## H. ADDITIONAL RESOURCES FOR PLANTING

The County of Los Angeles Fire Department's Forestry Division recommends the following may be contacted for additional information on noninvasive, fire-resistant and erosion-resistant trees, shrubs, ground covers, and grasses:

**County of Los Angeles  
Fire Department Prevention Bureau Forestry Division**

5823 Rickenbacker Road, Rm #123  
Commerce, CA 90040-3027  
(323) 890-4330

<http://fire.lacounty.gov/forestry/forestry.asp>

**United States Forest Service  
Pacific Southwest Research Station  
Forest Fire Laboratory**

4955 Canyon Crest Drive  
Riverside, CA 92507-6071  
(951) 680-1500

[www.fs.fed.us/psw/rfl](http://www.fs.fed.us/psw/rfl)

**The Theodore Payne Foundation**

For Wildflowers and Native Plants, Inc.  
10459 Tuxford Street  
Sun Valley, CA 91352-2126  
(818) 768-1802

[www.theodorepayne.org](http://www.theodorepayne.org)

**California Native Plant Society**

Los Angeles/Santa Monica Mountain Chapter  
15811 Leadwell Street  
Van Nuys, CA 91406-3113  
(818) 881-3706

<http://lasmmcnps.org>

**California Invasive Plant Council**

1442-A Walnut St. #462  
Berkeley, CA 94709-1405  
(510) 843-3902

<http://www.cal-ipc.org>

## C. EROSION

A complicating problem of storm or flood waters passing over land is often **erosion**. The result of erosion is often steep banks of scoured soil or other ground material. Remember that erosion:

- |               |   |
|---------------|---|
| <b>CANNOT</b> | be controlled while it is happening and is often not seen until the flood waters have subsided. |
| <b>CAN</b>    | seriously undermine structures, leading to major failures.                                      |
| <b>OCCURS</b> | most often when waters flow rapidly over loosely compacted soil or denuded slopes.              |

## A. GENERAL RULES

The previous section described various problems you may encounter during the rainy season. Below are some general rules to be followed in most cases involving flood waters, debris, and erosion

- NEVER** underestimate the power of debris flows.
- TRY** to direct debris flows away from improvements.
- AVOID** trying to control or confine the flows more than is absolutely required.
- CLEAR** a path for the debris.
- USE** your house or building as a deflector if necessary.
- ALWAYS** place protection to deflect debris, not to dam or stop it.
- DEBRIS** will often enter a building through windows - board them up.
- REMEMBER** to protect your most valuable property first - your home.
- THEN** consider what time and money are available to protect other less valuable objects such as swimming pools or landscaping.
- TRY** to install more permanent measures to protect your home. In general, the problem of debris flows will exist for several years after a burn. Sandbags usually last for only a year (**Figs. 18 and 19, page 21**)
- ALWAYS** work with adjacent affected property owners.
- BE** prepared to sacrifice the use of portions of your property to achieve the greatest amount of protection.
- AVOID** altering drainage patterns that could worsen conditions for your neighbor.

## F. PLANT SELECTION

The Forestry Division of the County of Los Angeles Fire Department recommends that when deciding what to plant, the homeowner should select plants for the desirable attributes of fire resistance, low maintenance, availability, and erosion control effectiveness.

## TREES

Trees are particularly valuable on steep hillsides. The roots of many trees go much deeper than those of most ground cover plants. Trees that resprout after burning are generally the best choice for wildland areas, so you do not have to replant and the roots continue to grow. Selections for new tree plantings may include California natives like Coast Live Oak, Valley Oak, Toyon, Alder, Black Walnut, and California Laurel.

## SHRUBS

Selections for new shrub plantings may include Aaron's Beard, California Fuchsia, Carmel Creeper, Creeping Rosemary, Creeping Sage, Dwarf Coyote Brush, Green Lavender-Cotton, Gray Lavender-Cotton, Small Leafed Ice Plants, and Point Reyes Ceanothus.

## GROUND COVERS

Selections for new ground cover plantings may include Bearberry Manzanita, Trailing African Daisy, Sunrose, and Woolly Yarrow.

## GRASSES

Selections for grass plantings or seeding may include Red Fescue and Bird's Foot Trefoil.





Fig. 23 UNCONTROLLED CHAPARRAL GROWTH

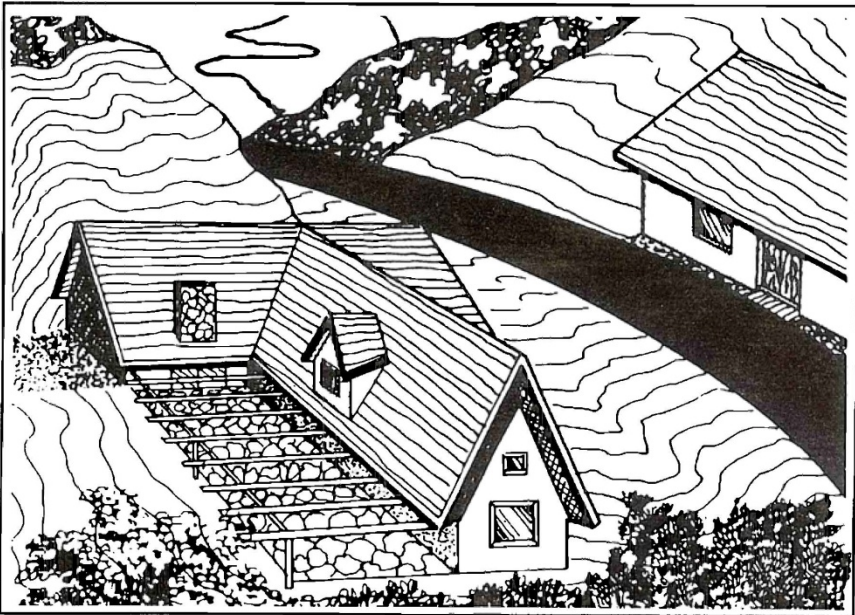

Fig. 24 HOMES PROTECTED FROM FIRE BY CLEARING

## B. FLOOD INSURANCE

Flood insurance under the National Flood Insurance Program is available throughout the County of Los Angeles unincorporated areas and in participating cities within the County of Los Angeles. To determine if your property is in a federally designated flood-hazard area, contact the city in which you reside. For unincorporated County areas, contact the County of Los Angeles Department of Public Works at (626) 458-4321.

If you have concerns that flooding may cause damage to your home, we strongly recommend that you contact your insurance broker regarding flood insurance. If your broker is unfamiliar with flood insurance, he/she can obtain information by contacting the Federal Emergency Management Agency (FEMA) at the following toll free number: 1-888-379-9531.

Remember flood insurance is available in participating communities, even if your property is not in a flood-hazard area identified by the Federal Government, the County, the city, or the subdivider of your property. Also, for insurance coverage purchased voluntarily, there is a 30-day wait period after the policy is issued before the coverage becomes effective.



Fig. 1 UNPROTECTED HOMES

### E. PLANTING GUIDELINES (continued)

#### PLANT

fire-retardant, noninvasive shrubs or trees where ground cover or grass ends. The Forestry Division of the County of Los Angeles Fire Department recommends large tree species should not be planted under or near utility lines. Low branching or wide-tree species should not be planted near roads and driveways where they can interfere with emergency vehicles. Typically, trees should not be planted closer than one-half of their mature width to roads and driveways.

#### STRESS

rapid growth ground cover.

#### INCREASE

effectiveness of fire-retardant plantings with deep irrigation practices, which encourage deep root growth. Drip irrigation will concentrate the water where it is needed. Conventional overhead irrigation often causes erosion on steep slopes.

#### REMEMBER

rains can normally be expected to start in October, so plan accordingly.

### E. PLANTING GUIDELINES (continued)

- USE** planting techniques similar to landscaping in newly developed areas for recently burned watersheds. In general, installing smaller plants often produce the best growth. Diversity in plant selection is more desirable than planting only a few types. Spreading shrubs and trees are easier to establish and reduce long-term weed problems often associated with large areas of ground cover.
- MINIMIZE** erosion with quick growing, fire-retardant ground cover planted with burlap mat, straw mulch, or chemical nutrients throughout areas to be protected.
- AVOID** large leafed Ice Plants (*Carpobrotus* sp) on slopes because it tends to “drag” surface soils down when saturated.
- SELECT** only fire-retardant noninvasive plants. The Forestry Division of the County of Los Angeles Fire Department notes the following commonly planted species as invasive: Capeweed, Australian Saltbush, Sea Fig/Ice Plant, Hottentot Fig, Pampas Grass, Broom, Russian Olive, Edible Fig, Blue Gum Eucalyptus, Algerian and English Ivy, Myoporum, Fountain Grass (all varieties), Canary Island Date Palm, Cape Plumbago, Black Locust, Brazilian and California Pepper Tree, Cape Honeysuckle, Periwinkle, and Mexican Fan Palm.

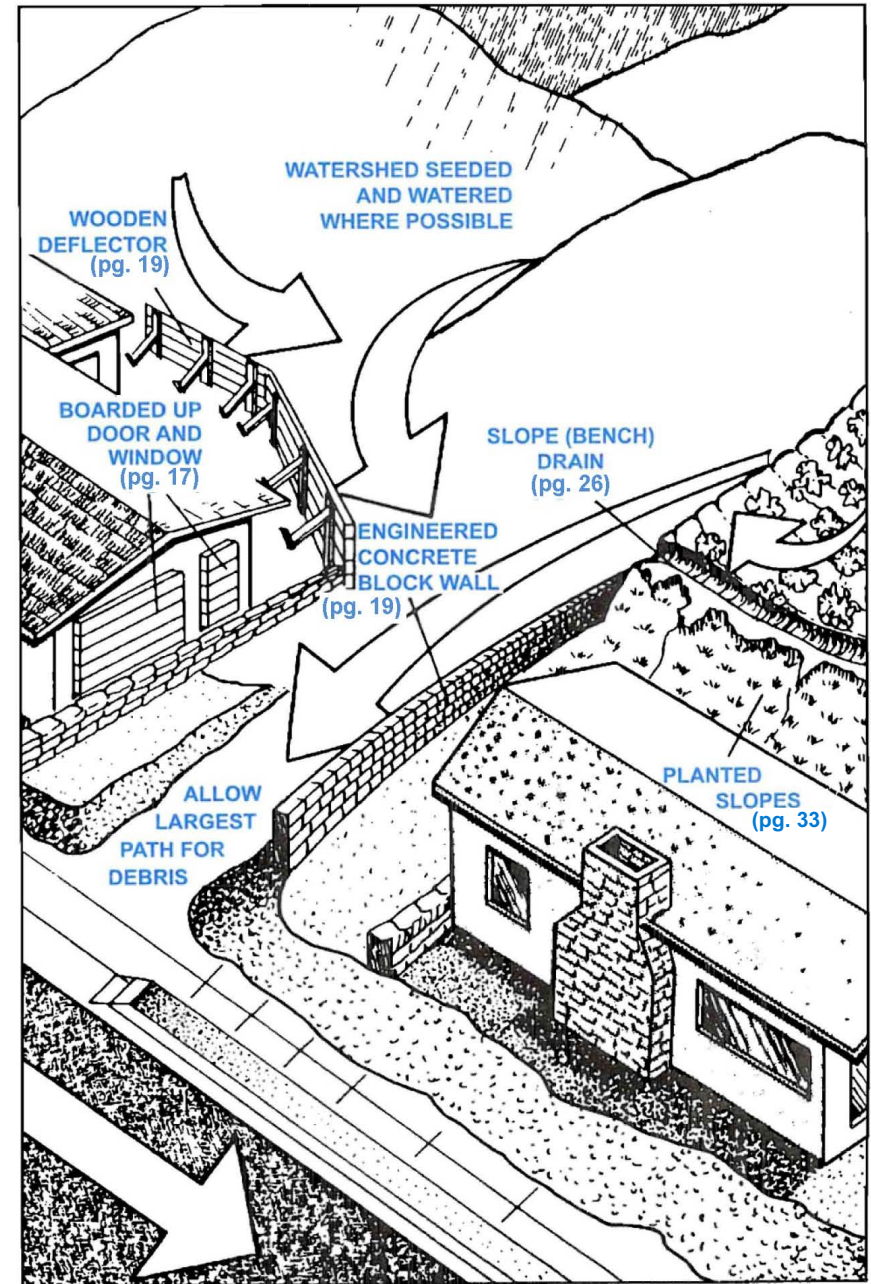
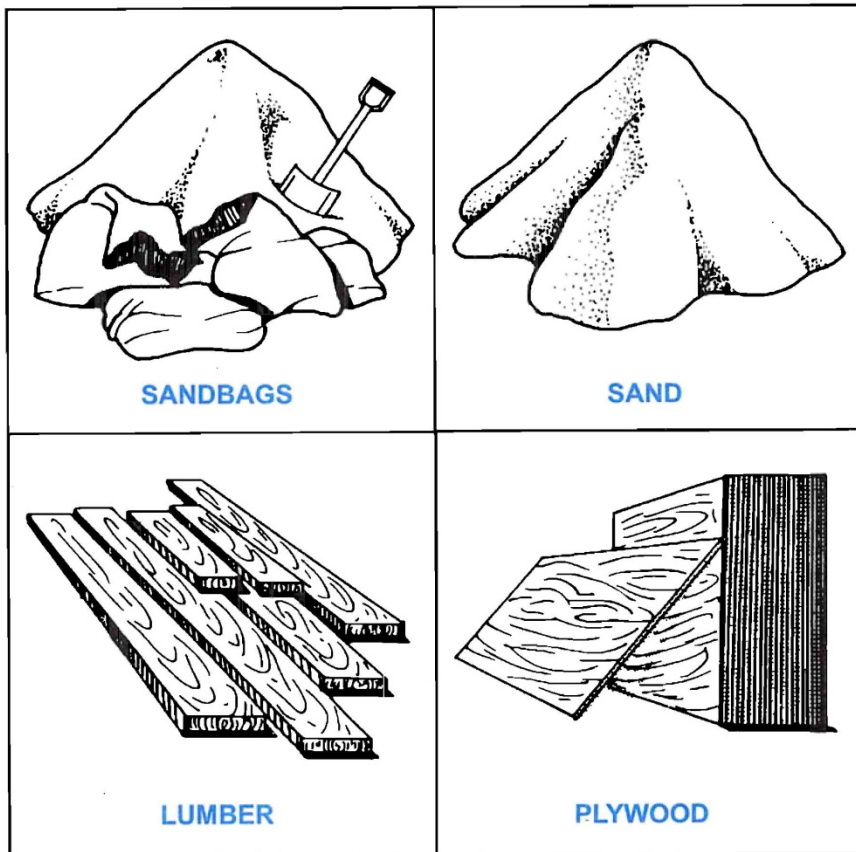

Fig. 2 HOMES PROTECTED FROM MAJOR DAMAGE

### C. DEBRIS CONTROL AIDS

- ARE** not expensive when compared to the protection received.
- CAN** be installed with normal household tools.
- CONSIST** of materials readily available at your local lumber yard (Fig. 3 below).



### E. PLANTING GUIDELINES

The key to erosion control is adequate planting to hold soil in place. However, planting can also increase fire hazards during warm weather. To reduce future fire hazards and still provide effective erosion control:

- CLEAR** native brush within 30 feet of buildings and limit brush height to 18 inches within 70 feet of buildings (Fig. 24, page 32). A limited number of specimen shrubs and trees can be allowed within 30 feet of a building (refer to your local fire codes for local requirements).
- ELIMINATE** or reduce chaparral-type plants that serve as fuel for fires and control their regrowth (Figs. 23 and 24, page 32). The Forestry Division of the County of Los Angeles Fire Department notes the following species: Chamise, Red Shank, California Sagebrush, Common Buckwheat, Sage, Pampas Grass, Cypress, Italian Jasmine, Pine, Cape Plumbago, Cape Honeysuckle, and some varieties of Eucalyptus and Juniper.
- KEEP** landscape clean. Remove litter under trees and shrubs and prune out dead growth. Remove dead and dry portions of ground cover and succulents. Leave space (15 to 20 feet) between remaining shrubs and trees to curtail the spread of fire.
- NOTE:** clearing or eliminating vegetation in streambeds, ecologically sensitive areas or the Coastal Zone may require permits or authorizations from Federal, State, or local environmental regulatory entities prior to the start of the activities. Contact your local Building and Safety Office for identification of Federal, State, and local agencies with regulatory authority over your property.

Fig. 3 TYPICAL MATERIALS

### D. NATURAL WATERCOURSE EROSION (continued)

- EDUCATE** yourself about the history of stream erosion in your particular neighborhood. Long-term residents and previous owners may have important information about past floods and erosion problems. Stay away from areas experiencing erosion during storms.
- PURCHASE** flood insurance to cover flood-related damages to structures (**page 5**). However, please note that damage to yards, earthwork, and outside equipment is generally not covered by flood insurance.
- BE AWARE** of increased or sudden erosion caused by storm flows, which may indicate a need to evacuate your residence.
- DETERMINE** a safe escape route from your home away from the stream in the event your home becomes undermined or flooded during a major storm.
- GATHER** basic necessities for possible evacuation and temporary relocation upon notification of a pending major storm.

### D. SANDBAGS

Sandbags, when properly filled and placed, will redirect storm and debris flows away from property improvements.

#### FILLING

1. Fill sandbags one-half full. Sand is suggested if readily available; however, sand is not mandatory, any local soil may be used.
2. For a more durable bag with increased effective life, mix 10 parts of sand or soil with 1 part of cement. The materials can be mixed and placed dry. After all bags are in place, a light sprinkling of water is recommended. This technique is only effective with burlap sandbags and will not work with plastic sandbags.



Fig 4. SANDBAG PLACEMENT

## D. SANDBAGS (continued)

### PLACING

Fold top of sandbag down and rest bag on its folded top (Fig. 4, page 9).

It is important to place bags with the folded top toward the upstream or uphill direction to prevent bags from opening when water runs by them.

Care should be taken to stack sandbags in accordance with the illustrations. Place each sandbag as shown completing each layer prior to starting the next layer. Limit placement to two layers unless a building is used as a backing or sandbags are pyramided (Figs. 5-11, pages 11-15).

### LIMITATIONS

1. Sandbags will not seal out water
2. Sand and soil filled burlap sandbags deteriorate when exposed for several months to continued wetting and drying. If bags are placed too early, they may not be effective when needed.
3. Sandbags are basically for low-flow protection (up to 2 feet). Protection from higher flows require a more permanent type of structure.

### CAUTION

Do not use straw or bales of hay in lieu of sandbags. They do not perform as well as sandbags and may be washed away.

## D. NATURAL WATERCOURSE EROSION

Many properties are adjacent to a natural watercourse or stream with minimal flows trickling periodically or continually throughout the year. During a major storm, these trickling flows may become a raging river, causing bank erosion and possibly undermining existing structures.

Structural solutions (concrete or riprap) to provide protection against bank erosion usually involve high costs and often require design services of a registered civil engineer. Regulatory agencies may also have special permit conditions if environmental concerns exist.

The following are a few helpful tips and economical measures that can be taken to lessen this type of flood threat to yourself: (For erosion outside of a natural watercourse, please refer to page 22.)

### CLEAR

the "low-flow" watercourse of debris, trash, and vegetative overgrowth before the storm season. Remove enough vegetation to keep the watercourse flowing. Contact your local Building and Safety Office for natural watercourse maintenance guidelines as well as identification of Federal and State agencies with regulatory authority.

### VEGETATE

bare stream banks to control erosion. Select planting material suited to both the intended use and specific site characteristics. Information regarding plant selection can be obtained from staff at a local nursery or a landscape architecture firm.

### C. SLOPE (BENCH) DRAINS

Drainage devices (including slope or bench drains), located throughout hillside areas, that are poorly maintained are the source of many flooding problems. With few exceptions, maintenance of these drains is the responsibility of the homeowner. KEEP THESE DRAINS CLEAR of debris and overgrowth (see Glossary). Blockage may cause undermining and structural failure of the drains or erosion of the hillside (Fig. 22 below)

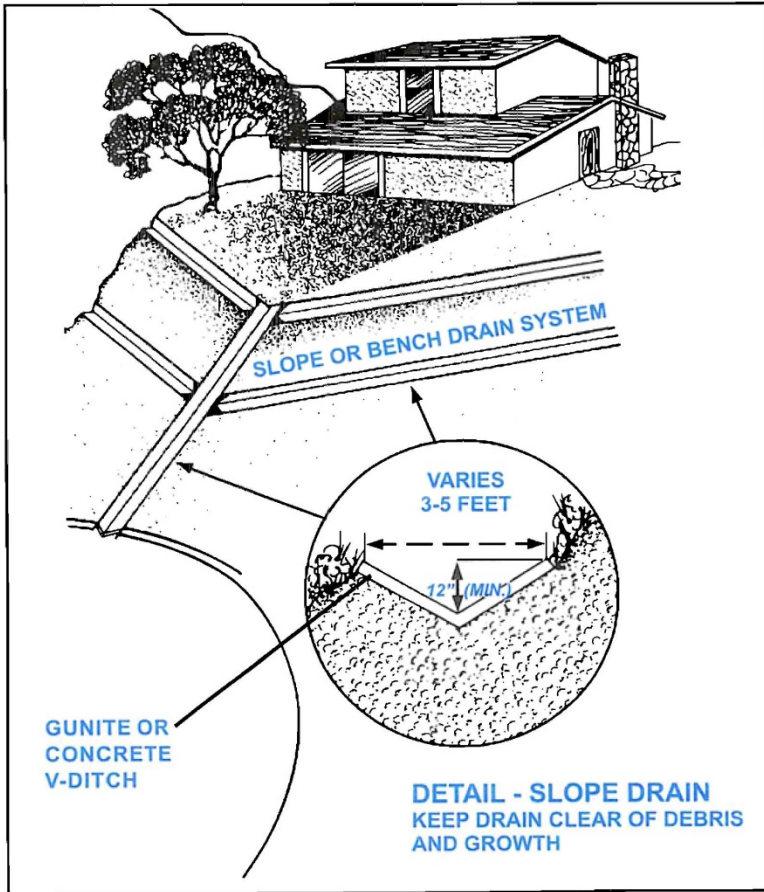

Fig. 22 SLOPE (BENCH) DRAIN

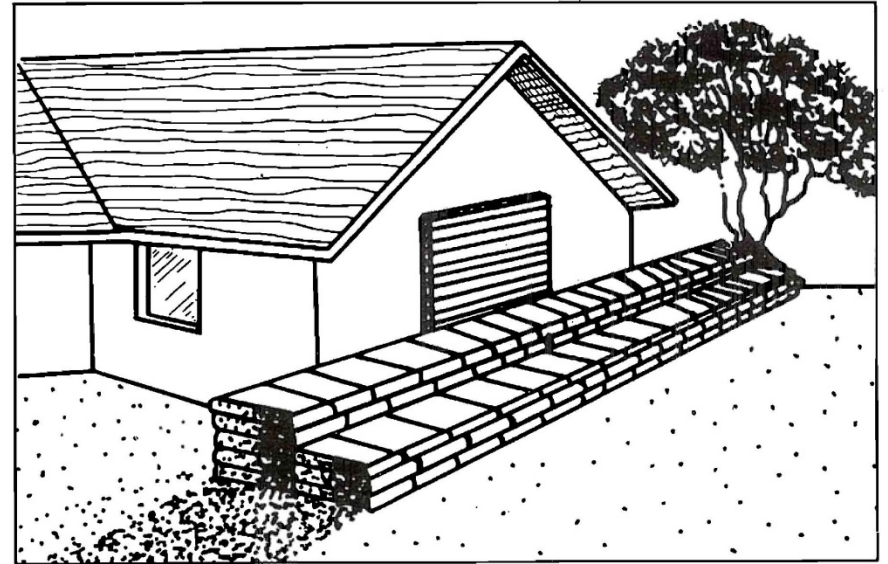

Fig. 5 SANDBAG STACKING AGAINST BUILDINGS

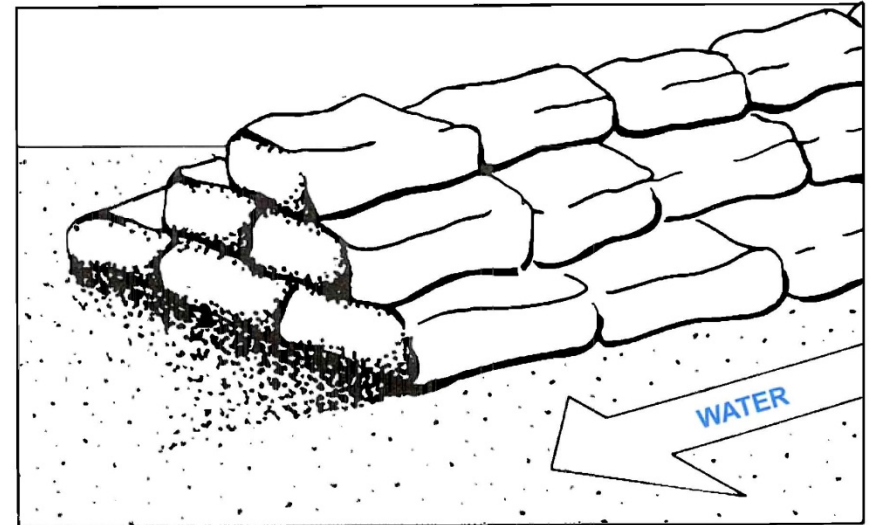

Fig. 6 PYRAMID SANDBAG STACKING

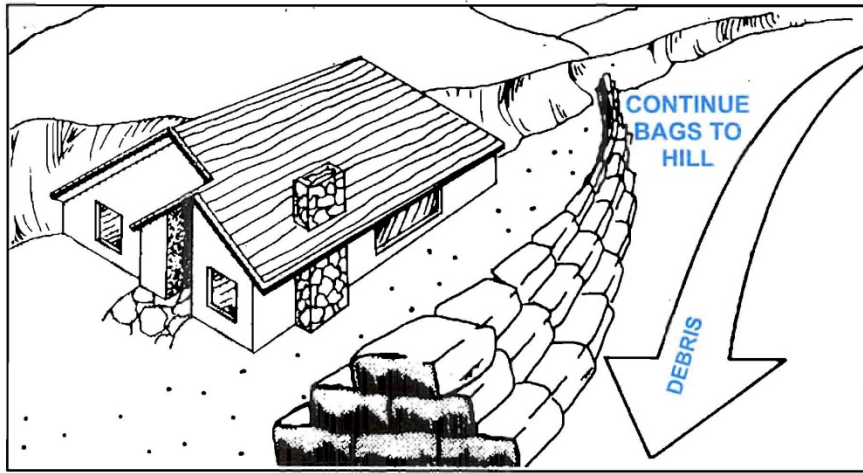

Fig. 7 DIRECTING DEBRIS AWAY FROM BUILDINGS

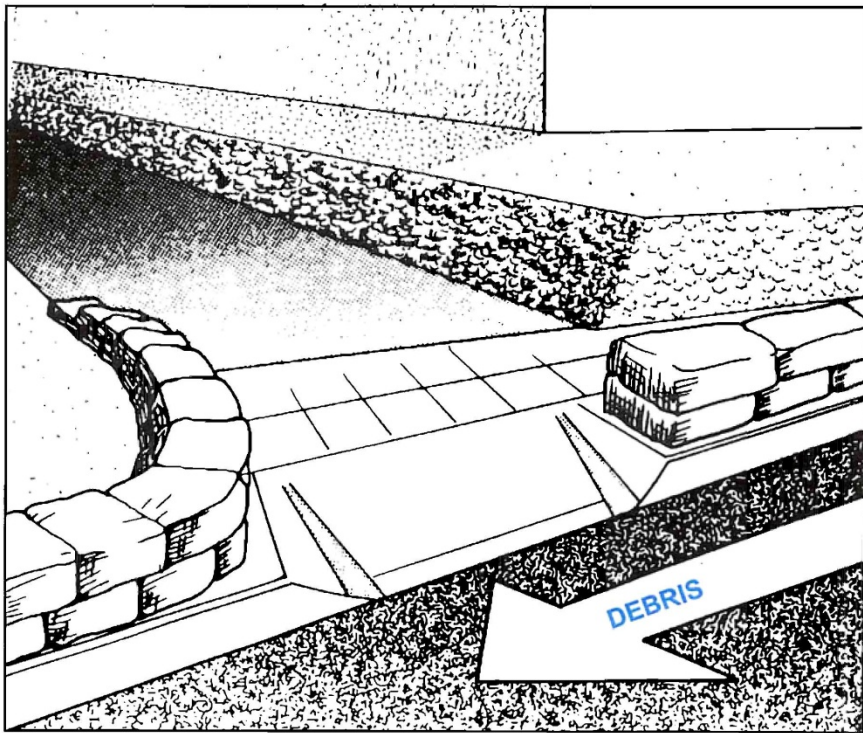

Fig. 8 CONTROLLING DEBRIS OR STORM FLOWS IN STREETS

**B. PROPERTY DRAINAGE HINTS TO HOMEOWNERS**  
(continued)

Do not let conditions on your property create a problem for your neighbors. Work with neighbors to minimize problems.

It is unlawful to divert flows from their natural path to the detriment of your neighbors.

Normal property drainage must flow to the street or an approved drainage device (Fig. 21 below). When landscaping, homeowners should avoid disrupting flow patterns created when the property was originally graded. Obstructions such as patios, sidewalks, and decks must not be placed in side swales unless an alternate method of drainage is provided. Deep ponding and saturation of the soil can result in severe property and foundation damage.

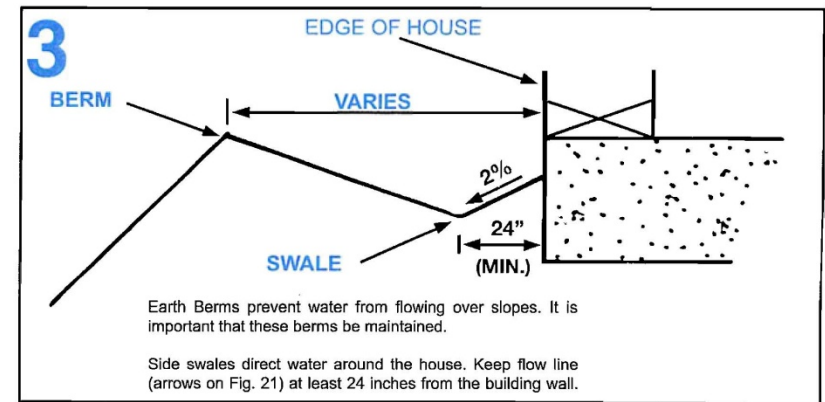
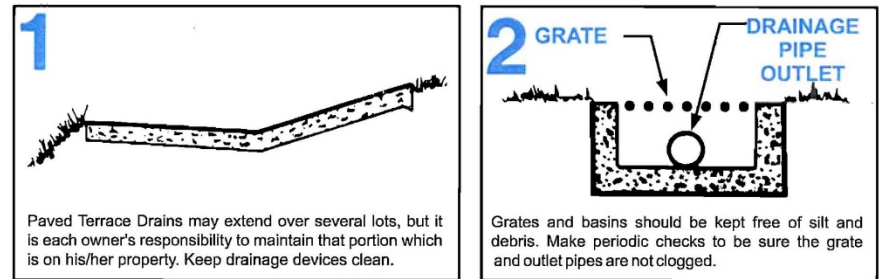

DETAILS TO Fig. 21



**B. PROPERTY DRAINAGE HINTS TO HOMEOWNERS**

Proper planting of slopes prevents erosion. Keep plants watered, but do not overwater. Replant barren areas.

Make inspections during rains. This is when trouble occurs. Watch for gullying. Correct problems as soon as possible.

Sandbags, tools, and sheets of plastic may come in handy during heavy rains. Keep them available.

If unusual cracks, settling, or earth slippage starts, immediately consult a qualified civil engineer or geologist.

Do not alter your slopes or drainage without expert advice. Consult a state licensed civil engineer.

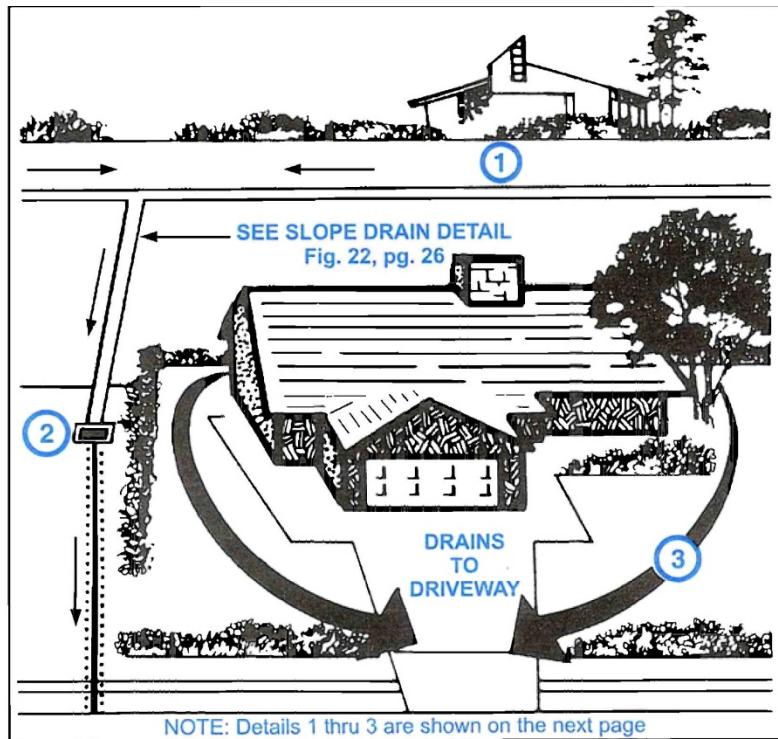

Fig. 21 PROPERTY DRAINAGE

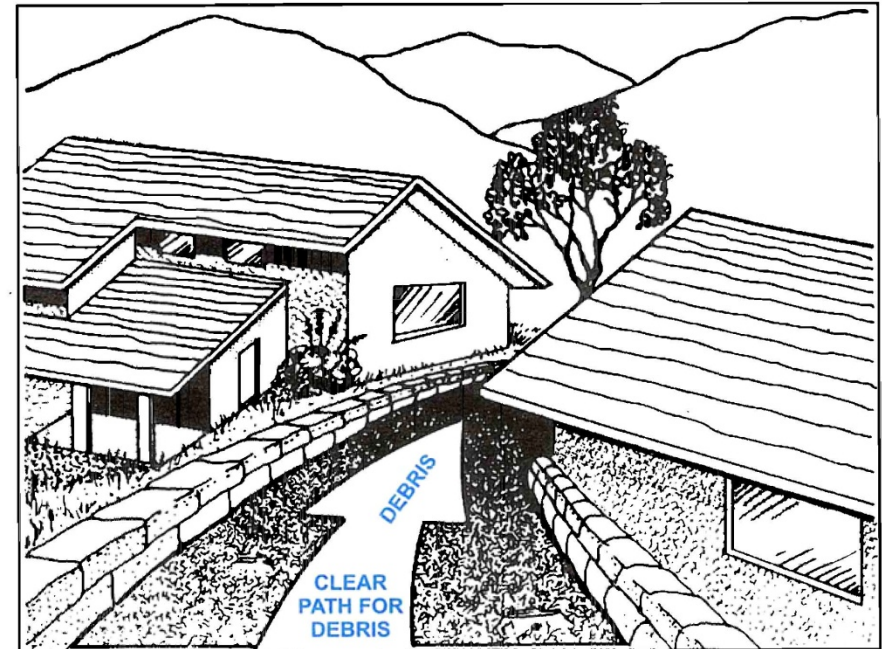

Fig. 9 DIRECTING FLOWS BETWEEN BUILDINGS

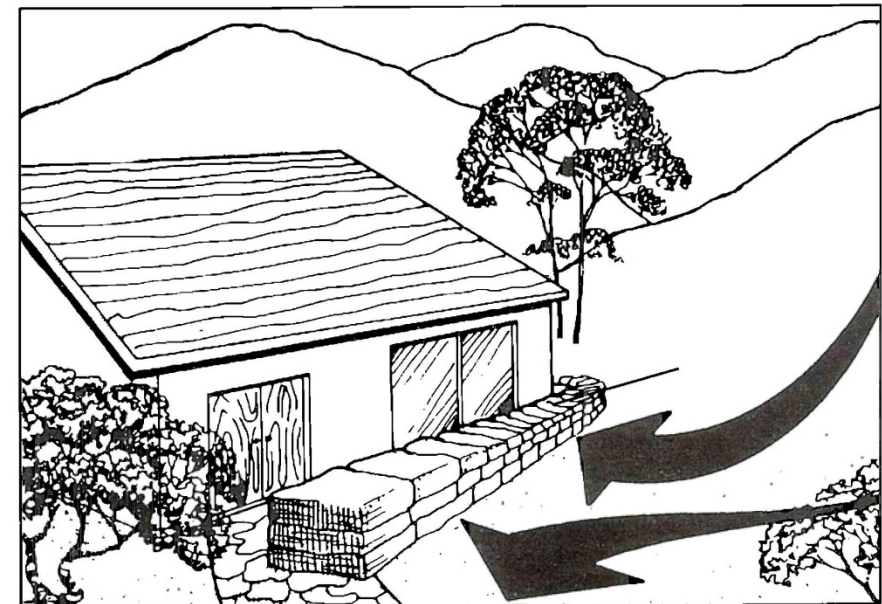

Fig. 10 BUILDING PROTECTION

## E. CONTROL OF WATER INTRUSION

### DOOR SEALING

To prevent water from seeping through a door, a rubber seal (similar to weather stripping) should be affixed to the door frame. When the door is closed, a watertight seal should result (Fig. 12, page 16).

### SLIDING GLASS DOOR SEALING

To prevent water from seeping around a sliding glass door, a plastic sheet (2 to 3 mm thick) should be placed between the door and the sandbags or between the door and the plywood barrier (Fig. 11, page 15). This is not recommended for water levels above 2 feet.

### SUBMERSIBLE SUMP PUMPS

In cases where water has flooded a basement, garage, or any low-lying area, a submersible sump pump is recommended. If flooding is a recurring problem, a permanent pump should be installed in a sump with a floatation device for automatic on/off operation (Fig. 13, page 16).

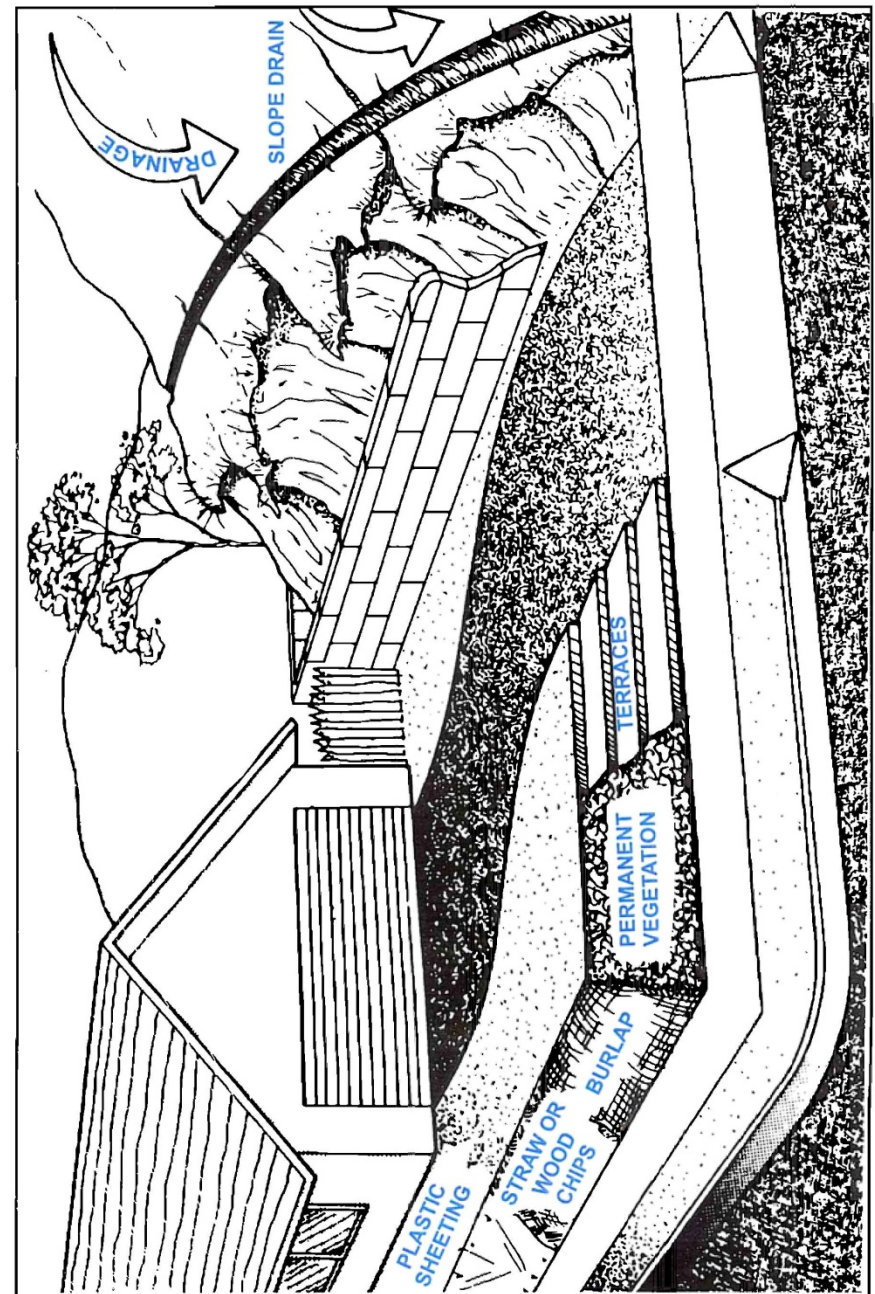

Fig. 20 EROSION CONTROL

A. GENERAL PROPERTY GUIDELINES

1. CONTROLLING WATER FLOWING INTO PROPERTY

Dig a small ditch with a hoe or shovel fairly close to the upper edge of the property. Build the ditch nearly on the horizontal to ensure slow water movement. Provide for the ditch to drain into a natural watercourse or onto street pavement or to a well vegetated area (Fig. 20, page 23).

2. CONTROLLING RUNOFF ON SLOPES

Dig the same type of small ditch at the top of each steep slope. Do not allow large amounts of water to concentrate along one route. On soils especially susceptible to erosion, additional protection can be gained by using inexpensive plastic sheeting. These sheets should be overlapped like shingles and securely tied or weighted down so that the majority of water does not reach the soil. Shrubs may be planted through the plastic by cutting a hole just large enough for growth (Fig. 20, page 23). Where ditches are used in unstable soil, the ditch should be sowed with perennial grasses (page 33). NOTE: Plastic sheeting should not be used as a permanent solution as it retards vegetation establishment.

3. STRENGTHENING THE SOIL TO RESIST EROSION

Straw or wood chips are effective in holding the soil in place. They have the added value of increasing the organic content of the soil. Either material should be worked into the top few inches of the soil. Place a covering of chips 1 inch (or less) as slope and soil conditions indicate (Fig. 20, page 23). Nitrogen fertilizer should be added.

Woven burlap can be laid on the slope and tied down with stakes to prevent lifting by wind or water (Fig. 20, page 23). Regular planting procedures can be followed before laying the burlap since it will not interfere with establishing growth on the slope. The burlap will decompose eventually, but will remain long enough for vegetation to become well established.



Fig. 11 SLIDING GLASS DOOR SEALING

Control of flows to prevent seeping around sliding glass doors.

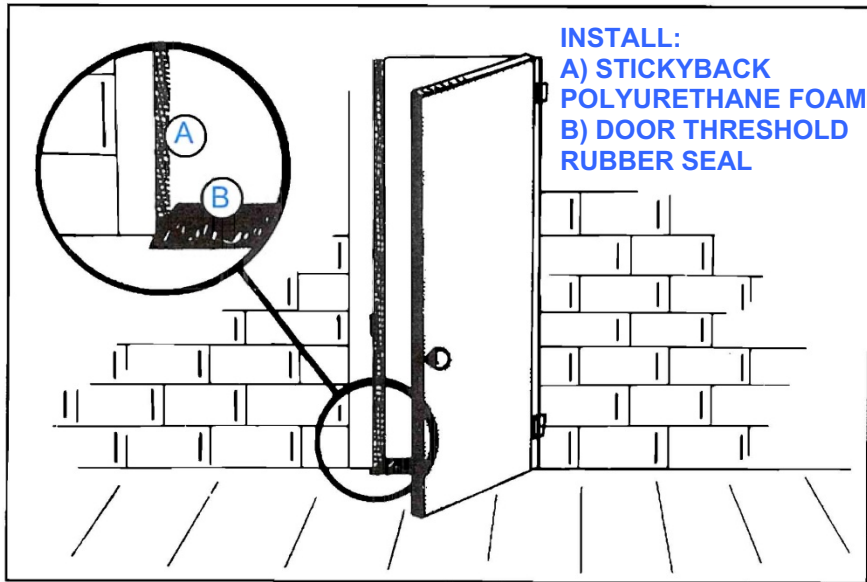

Fig. 12 DOOR SEAL

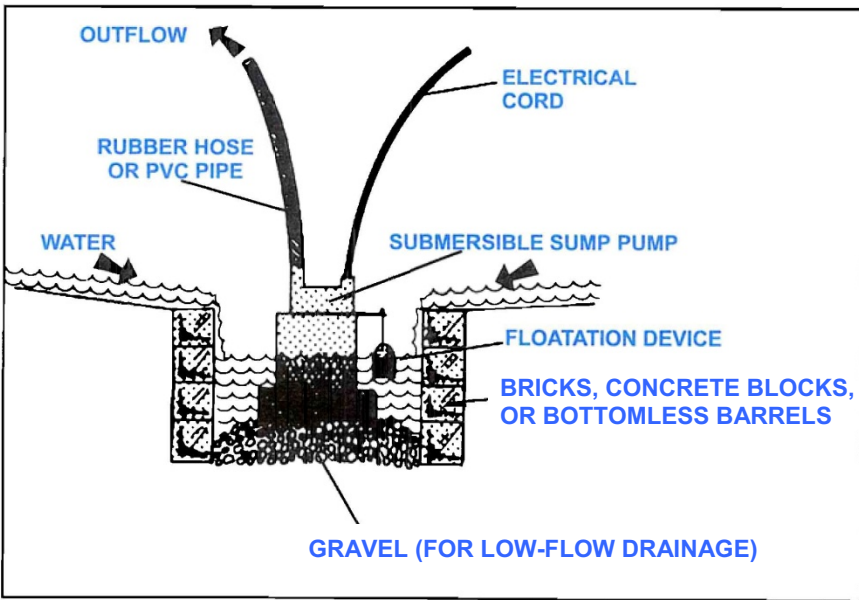

Fig. 13 SUBMERSIBLE SUMP PUMP

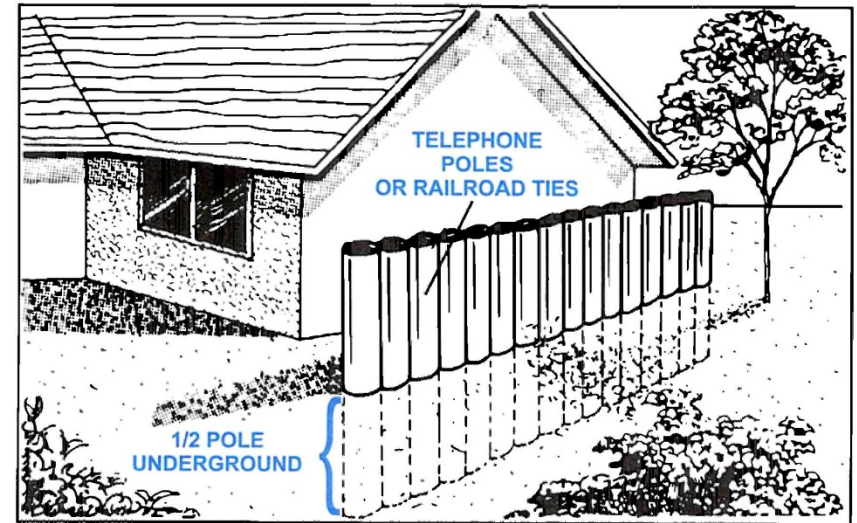

Fig. 18 TELEPHONE POLE OR RAILROAD TIE BARRIER

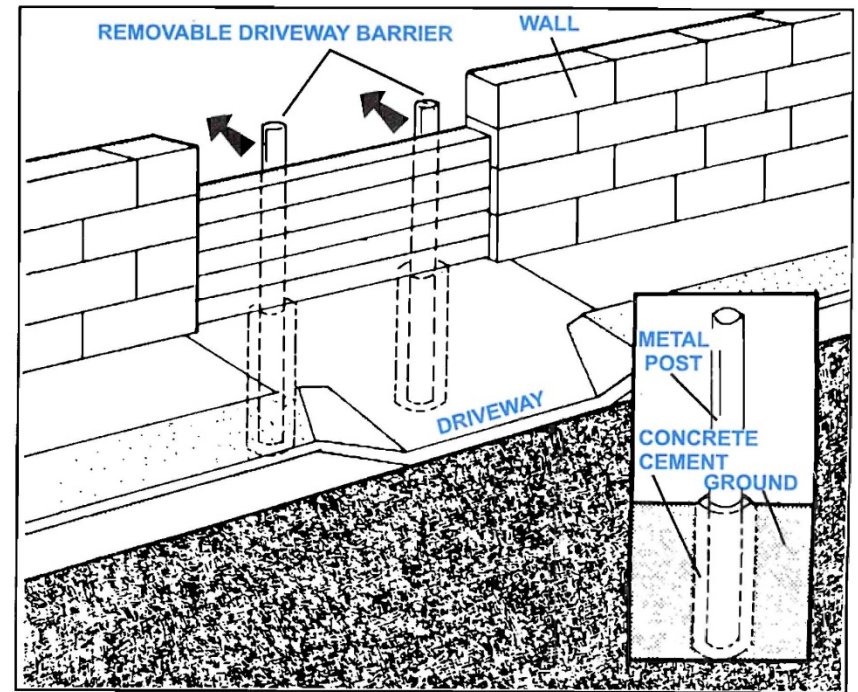

Fig. 19 REMOVABLE DRIVEWAY BARRIER

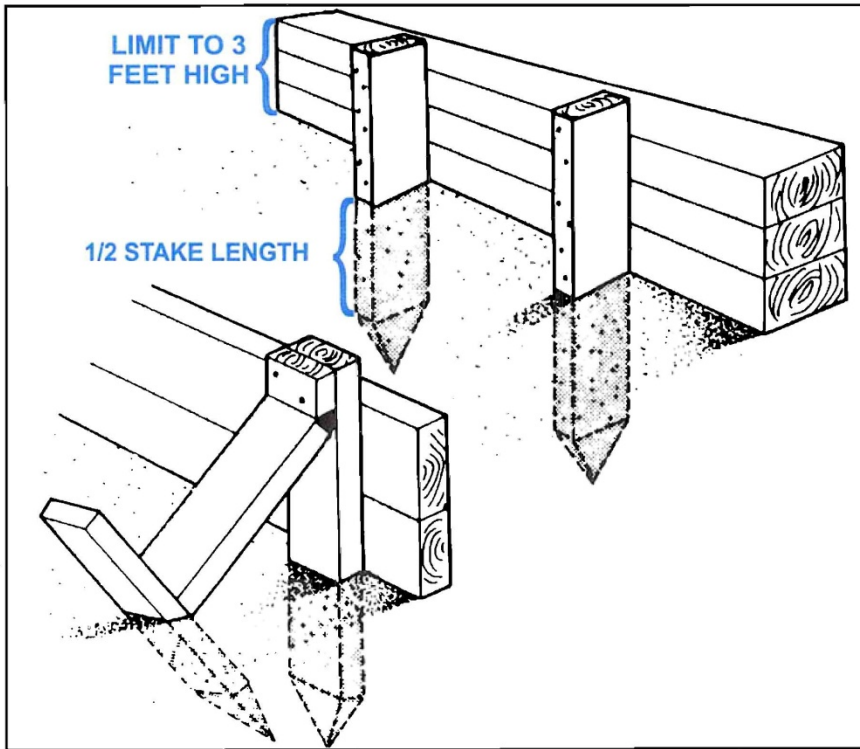

Fig. 16 TYPICAL TIMBER INSTALLATION

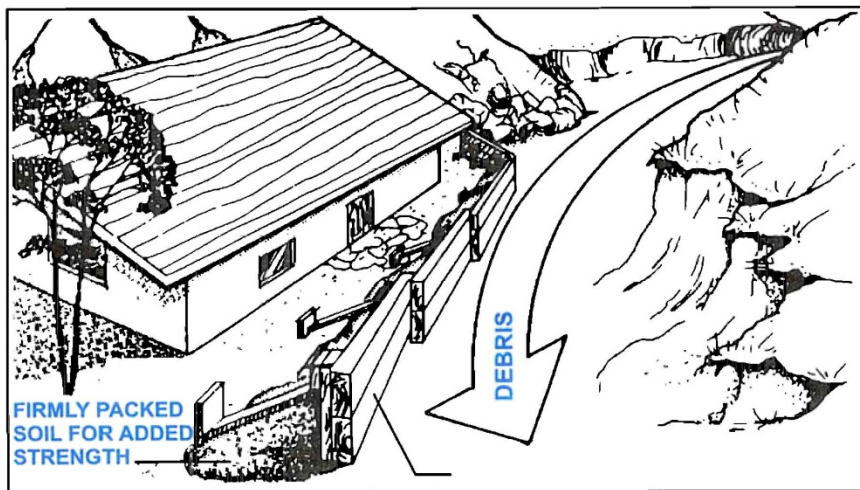

Fig. 17 TIMBER DEFLECTOR

## F. DEFLECTION DEVICES AND BUILDING PROTECTION

### DOOR AND WINDOW PROTECTION

- PROVIDE** protection against debris entering around doorways and windows by use of boards or plywood (Figs. 14 and 15, page 18)
- COVER** doors and windows completely with plywood, if affected by the hazard, and use an alternate entrance.
- USE** low-grade plywood to overlap windows, vents, and doors 3 to 4 inches on all sides.
- SECURE** each sheet of plywood with 4 or more nails, screws, or bolts; stakes and boards may also be used to wedge barriers in place. As an alternative, standing pipes on both sides of a door may be used to secure a removable barrier (Fig. 14, page 18).
- MATERIALS** can be dismantled after the storm season and stored year-to-year.

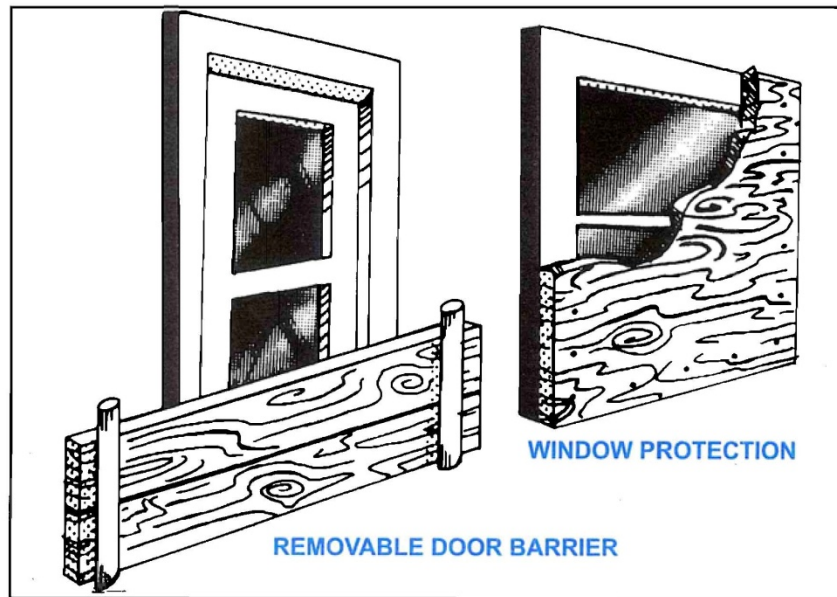

Fig. 14 TYPICAL WINDOW AND DOOR PROTECTION

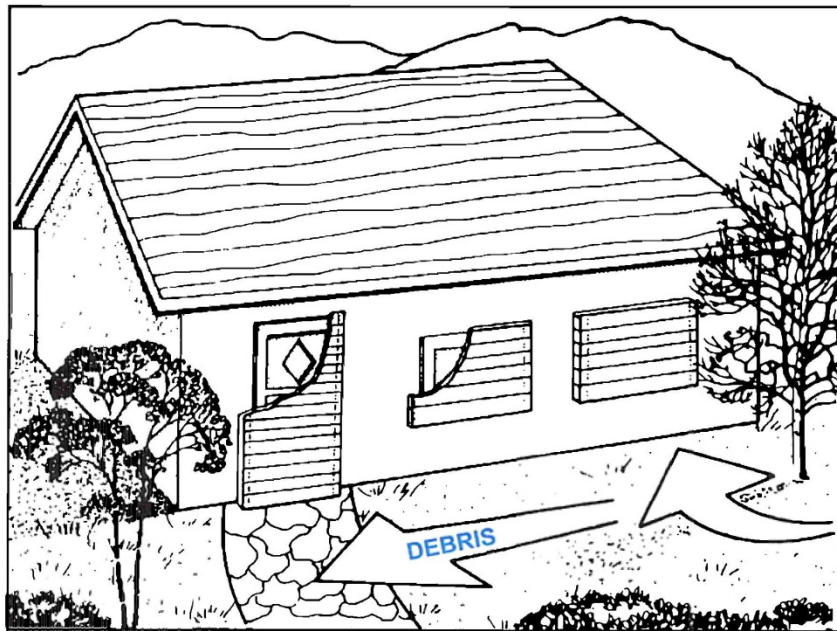

Fig. 15 USE OF WINDOW AND DOOR PROTECTION

## F. DEFLECTION DEVICES AND BUILDING PROTECTION (continued)

### DEBRIS DEFLECTORS AND BARRIERS

- USE** low-grade lumber and overlap section with protruding end facing downstream (Fig. 17, page 20).
- DRIVE** stakes to at least one-half their length to ensure proper anchorage (Fig. 16, page 20).
- PLACE** deflectors on solid, level soil if possible to reduce the hazard of undercutting.
- DO NOT** attempt to use the lumber as a dam.
- SOIL** firmly packed behind the deflector will provide needed additional strength (Fig. 17, page 20).
- PLACE** sandbags against the house if debris deflector required is greater than 3 feet (Fig. 5, page 11).

### G. ENGINEERED CONCRETE BLOCK WALLS

Concrete block walls that are designed and built to withstand loads caused by water and debris are excellent for protection and durability. In many cases, such walls can be adapted to become part of the landscaping. These walls generally are expensive and should be considered permanent installations. **CAUTION: DO NOT RELY ON NONENGINEERED WALLS FOR PROTECTION.**